

PRESS-CHECK

Thermography Based Test System During Press Hardening



System Description

The combination of forming and hardening in the production of sheet metal parts, for example in the automotive industry, allows a high stability and stiffness of the components with a simultaneous reduction of sheet thickness. This process is called hot forming.

The specially developed automated test system PRESS-CHECK by InfraTec monitors the temperature distribution throughout the sheet metal part surfaces with several high-performance infrared cameras of different wavelengths. A high-resolution camera in the shortwave infrared range (SWIR) enables high-precision temperature sensing of up to 950 °C heated plates before start of the press procedure. In addition, the camera automatically detects the contours of the plates, and hence automatically generates measurement fields. Thus, an erroneous positioning inside the tool is prevented. Accidentally superimposed sheets of metal can also be detected. The error message is directly submitted to the machine control, so that the press process can be stopped immediately. In this way, any increased tool wear or even tool damage can be avoided.

During press hardening, the sheet metal parts are cooled, so that the microstructure of the component is being modified in a way that the desired material properties can be achieved. Therefore, a homogeneous temperature distribution over the entire sheet surface is necessary which can be measured perfectly with infrared cameras. In contrast to a point measurement, for example by pyrometer, uniformly high stability of all pressing parts can be secured.

Whether or not the defined cooling process during the press process takes place within quality limits can be determined with the help of additional infrared cameras. The long-wave infrared cameras (LWIR) are ideally suited to detect precise temperature ranges and temperature distribution of the formed sheets. In case the evaluation software reports faulty components, it is automatically reported to the machine control and the parts are sorted out. High rejection rates are therefore preventable, costs will be reduced and productivity increased.



IR cameras in protective housing for measuring prior and after pressing



Evaluation unit



IR camera in a special protective housing for measuring after pressing

Software PRESS-CHECK

With the help of the PRESS-CHECK software the various tools can be managed automatically, and associated measurements can be analysed and recorded. Thus, the system is universally applicable for all orders running on the press line without any changeover time. In comparison to other solutions PRESS-CHECK allows for uninterrupted operation which is a distinct advantage of this system.

With highly reliable components, special protective housings, flexible layout and data interfaces, the test system can be easily adapted and integrated to the conditions of different press lines.

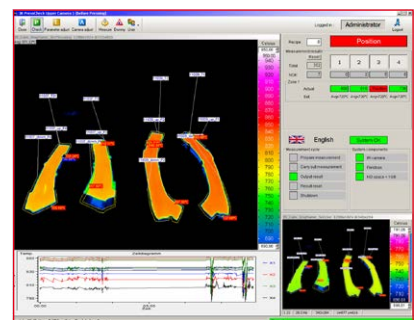

Test software PRESS-CHECK

Headquarters

InfraTec GmbH
Infrarotsensorik und Messtechnik
Gostritzer Straße 61 – 63
01217 Dresden / GERMANY

Phone +49 351 871-8630
Fax +49 351 871-8727
E-mail thermo@InfraTec.de
www.InfraTec.eu

USA office

InfraTec infrared LLC
5048 Tennyson Pkwy.
Plano TX 75024 / USA

Phone +1 844-226-3722 (toll free)
E-mail thermo@InfraTec-infrared.com
www.InfraTec-infrared.com

PRESS-CHECK

Thermography Based Test System During Press Hardening

Features at a Glance

- Control of the temperature distribution before and after press hardening
- Monitoring of the entire sheet metal surface
- Presence detection, position recognition, double sheet detection
- Monitoring of tool wear
- Fully automatic, process-synchronous operation
- No changeover times; automatic contour detection of the sheets
- Automatic rejection for faulty sheets and interruption of press if process is not carried out within the regulatory limits
- Automatic data transfer via superior machine control about bus systems like PROFIBUS, Modbus, CC-Link
- Minimal training effort due to intuitive user interface
- Secure handling and access control with user management
- Long-term recording and archiving of all measurement data for later analysis

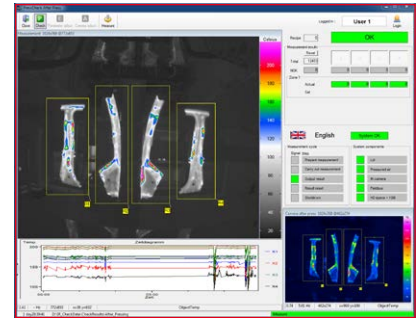

Test software PRESS-CHECK

System Structure

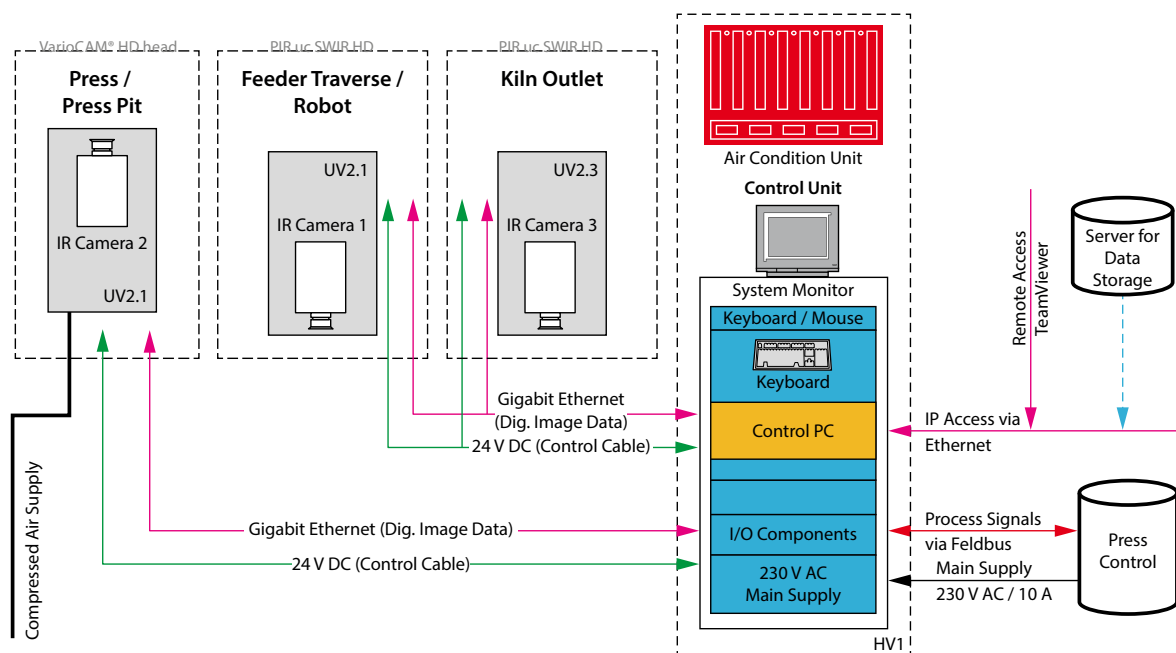

- High-quality infrared cameras of the latest generation guarantee reliable long-term measurements of temperature distribution
 - VarioCAM® HD head camera (LWIR) with (640 × 480) or (1,024 × 768) IR pixels
 - PIR uc SWIR HD camera (SWIR) with (1,280 × 1,024) IR pixels
- Cabinet with robust 19" industry technology
- Special protective housing in the press pit with pneumatic lens cover and air knife for harsh environments
- Continuous operation and low-maintenance guarantee
- Customised IR-lenses for optimal monitoring